

L-Cube

LC 5837

Montagehandleiding

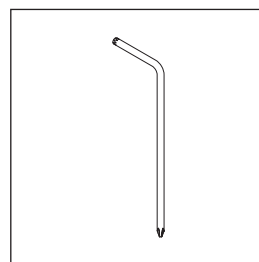
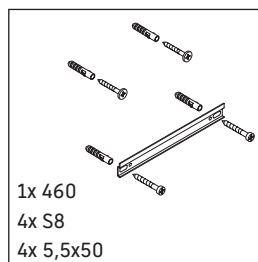
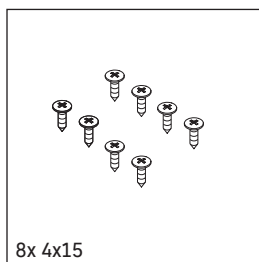
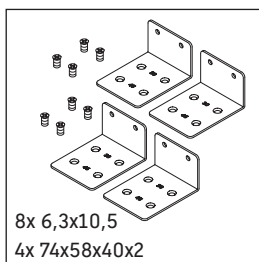
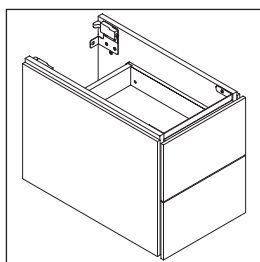
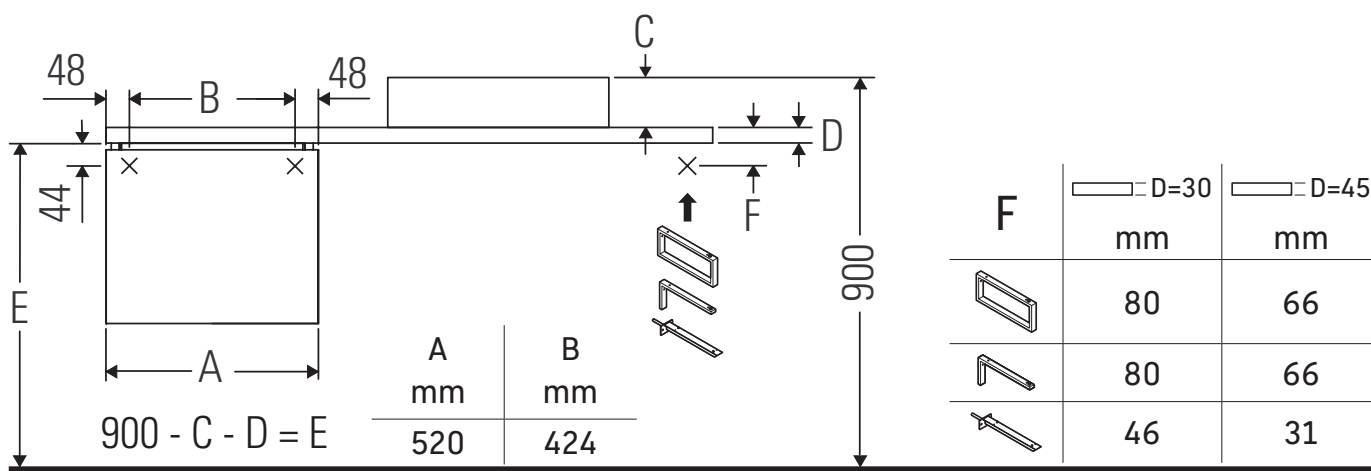

Neem de boor-afmetingen in acht!



Neem alle overige montagehandleidingen in acht!

Aanwijzingen betreffende het gebruik

De badmeubel-serie voldoet aan de geldende normen en richtlijnen op het moment van de levering en is ontworpen voor gebruik in badkamers. Een direct contact met water, bijv. bij het douchen moet worden vermeden.

Keramische producten breder dan 600 mm moeten aan de wand worden bevestigd.

Wij behouden ons het recht voor om technische verbeteringen en optische veranderingen aan de afgebeelde producten aan te brengen.

