

DuraStyle

DS 6381

Montagehandleiding

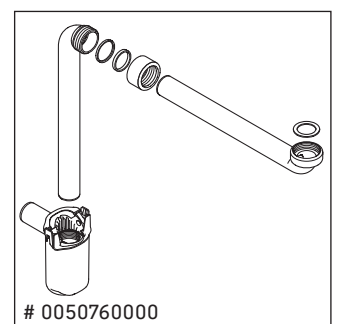
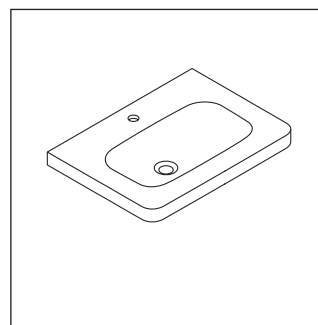
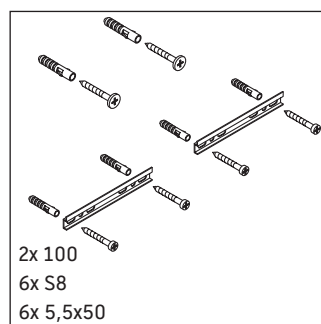
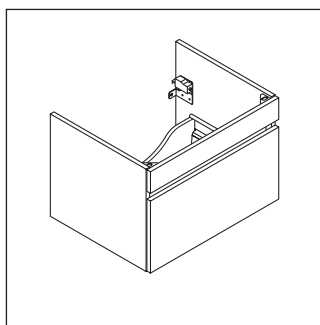
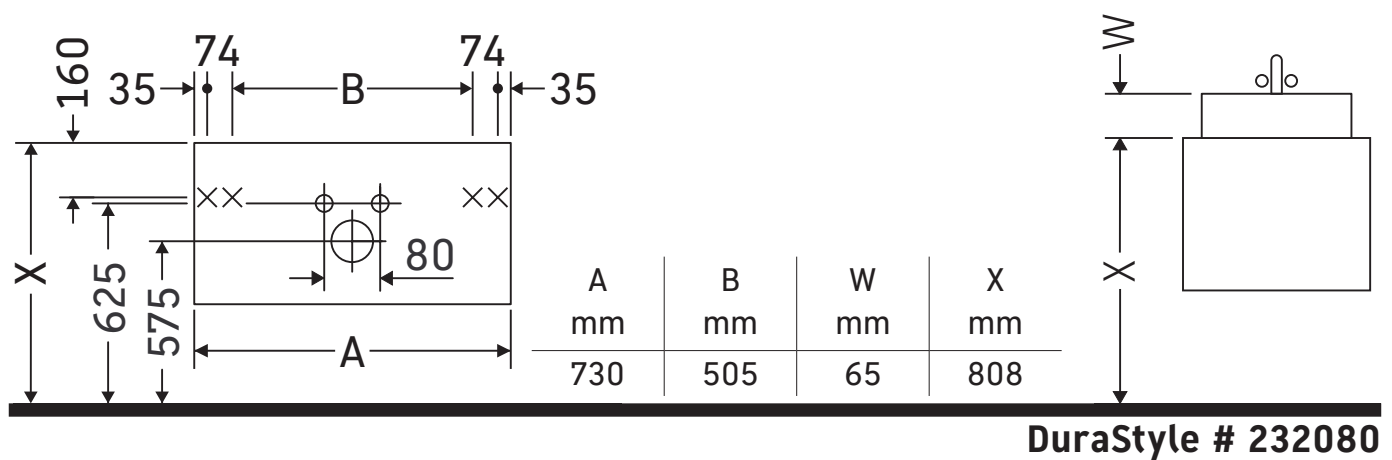

Aanwijzingen betreffende het gebruik

De badmeubel-serie voldoet aan de geldende normen en richtlijnen op het moment van de levering en is ontworpen voor gebruik in badkamers. Een direct contact met water, bijv. bij het douchen moet worden vermeden.

Wij behouden ons het recht voor om technische verbeteringen en optische veranderingen aan de afgebeelde producten aan te brengen.

